

Product availability: Non-Stock - Not normally stocked in distribution facility

Price*: 305.59 USD



Main

Range of Product	Modicon M171/M172
Product or Component Type	Additional I/O module
Product Specific Application	HVAC and pumping solution
Number of inputs/outputs	27
Discrete input number	8
Discrete output number	3 relay outputs SPST with same common 2 relay outputs SPST with same common 2 relay outputs SPDT with independent common
Discrete output current	8 A relay SPDT 5 A relay SPST
Analogue input number	2 analog input NTC 4 configurable
Analogue output number	3 voltage/current 4...20 mA or 0...10 V 2 open collector 1 kHz, 12 V, 35 mA

Complementary

Number of port	1 CAN port - screw terminal block
Input/output number	6 analog input 5 analog output 8 digital input 7 digital output 1 high-speed counter
Discrete input logic	Sink or source (positive/negative)
Discrete input voltage	24 V AC/DC 48 V DC
Discrete input current	2.5 MA
Input impedance	20 kOhm
Analogue input type	Voltage 0...5 V ratiometric) Current 4...20 mA Impedance 0...1500 hOhm Impedance 0...300 daOhm Direct input NTC temperature probe - 50...110 °C 0.1 °C extended) Voltage 0...10 V Pt 1000 temperature probe - 200...800 °C 0.1 °C NTC temperature probe - 40...150 °C 0.1 °C

Sensor power supply	5 V DC 50 mA 12 V DC 150 mA
[Us] rated supply voltage	24 V AC 48 V
Realtime clock	Without -4...131 °F (-20...55 °C)
Display type	Without Display
Overvoltage category	II
Mounting Support	DIN rail
Maximum Width	5.51 In (140 mm)
Maximum Height	4.33 In (110 mm)
Maximum Depth	2.43 In (61.6 mm)
Net Weight	0.42 Lb(US) (0.19 kg)

Environment

Directives	86/188/EEC - physical agents (noise) directive 2006/95/EC - low voltage directive
Standards	EN/IEC 60730
Product Certifications	CE CURus EAC CSA
Ambient air temperature for operation	-4...131 °F (-20...55 °C) UL 60730-1
Ambient Air Temperature for Storage	-40...185 °F (-40...85 °C)
Relative humidity	10...90 % non-condensing
IP degree of protection	IP20
Pollution degree	2

Ordering and shipping details

Category	22537 - M171 / M172 HVAC CONTROLLERS
Discount Schedule	PC12
GTIN	03606480752711
Nbr. of units in pkg.	1
Package weight(Lbs)	16.12 Oz (457 g)
Returnability	No
Country of origin	IT

Packing Units

Unit Type of Package 1	PCE
Package 1 Height	5.12 In (13 cm)
Package 1 width	3.58 In (9.1 cm)
Package 1 Length	7.28 In (18.5 cm)
Unit Type of Package 2	S02
Number of Units in Package 2	6
Package 2 Weight	6.69 Lb(US) (3.036 kg)
Package 2 Height	5.91 In (15 cm)
Package 2 width	11.81 In (30 cm)
Package 2 Length	15.75 In (40 cm)

Offer Sustainability

Sustainable offer status	Green Premium product
California proposition 65	WARNING: This product can expose you to chemicals including: Lead and lead compounds, which is known to the State of California to cause cancer and birth defects or other reproductive harm. For more information go to www.P65Warnings.ca.gov
REACH Regulation	REACH Declaration
EU RoHS Directive	Pro-active compliance (Product out of EU RoHS legal scope) EU RoHS Declaration
Mercury free	Yes
RoHS exemption information	Yes
China RoHS Regulation	China RoHS Declaration
Environmental Disclosure	Product Environmental Profile
Circularity Profile	End Of Life Information
WEEE	The product must be disposed on European Union markets following specific waste collection and never end up in rubbish bins.

Dimensions

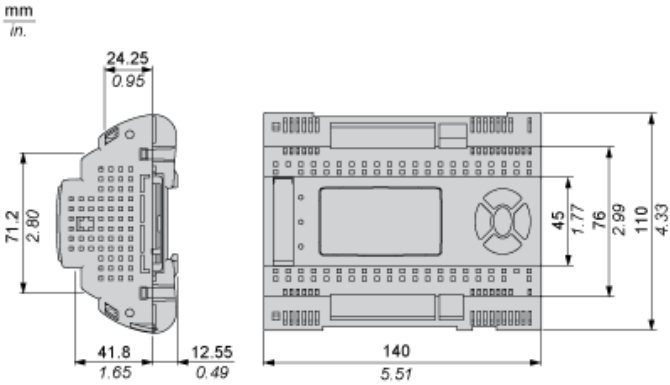

Mounting and Clearance

Clearance

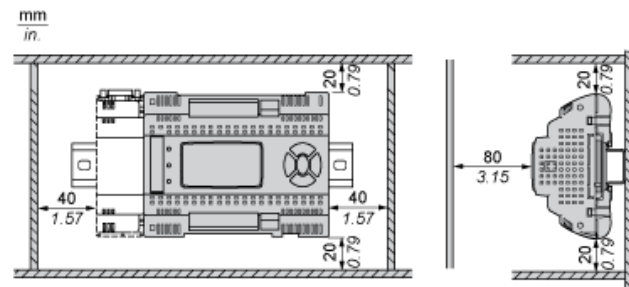

Misplacement

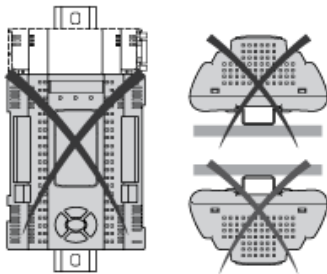

Power Supply



Digital Inputs

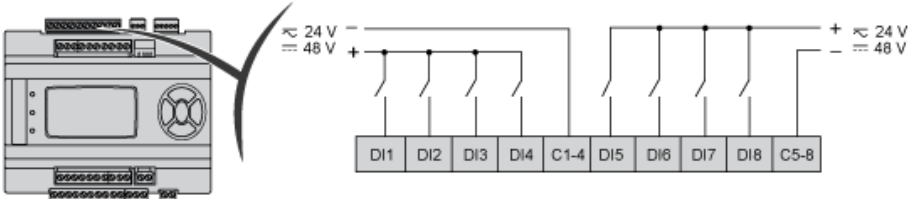

Analog Inputs

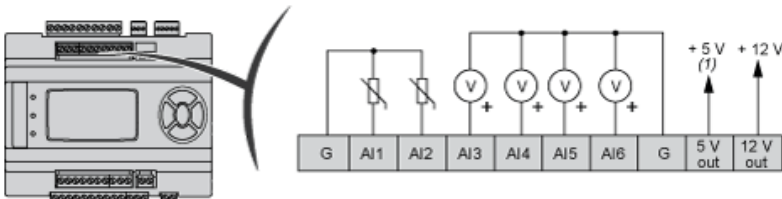

(1) Max current: 50 mA.
G : Ground

Analog Outputs

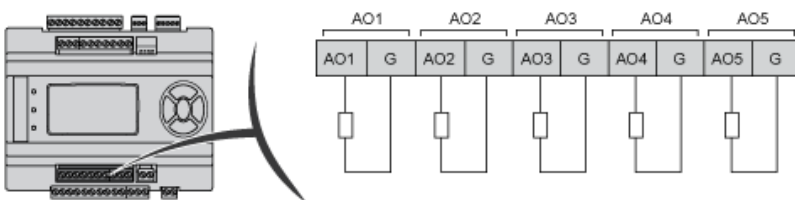

Digital Outputs

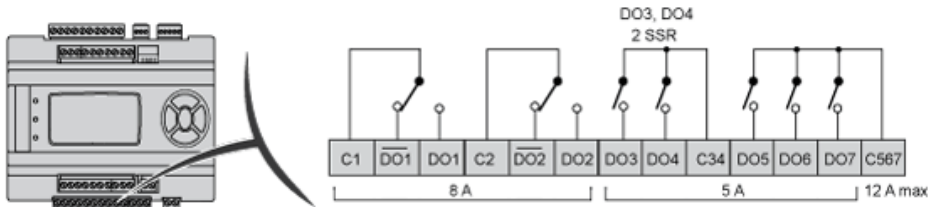

C: common

Fast Digital Input

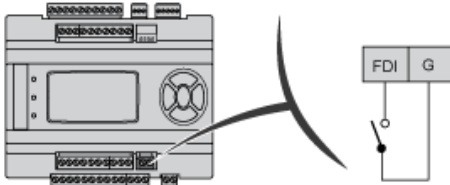

Serial Line Port (RS 485)

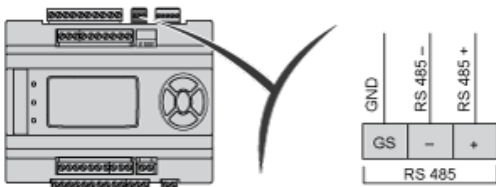

Apply 120 Ohm terminal resistance
GS serial GND isolated from G

CAN Expansion Bus

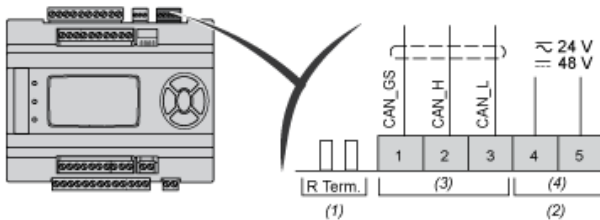

- (1) CAN terminal resistance
- (2) Output for remote keyboard
- (3) CANOPEN
- (4) Power Out

4 DipSwitches



- (1) 4 DIP SWITCH
LOW Address

6 - 10 DipSwitches

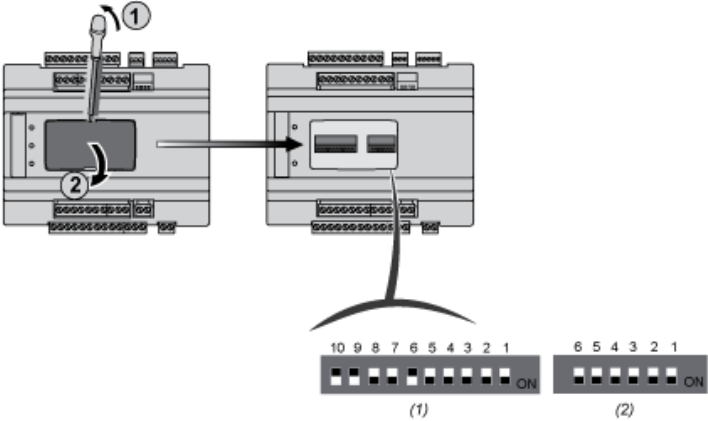

- (1) 10 DIP SWITCH
- (2) 6 DIP SWITCH

Product Life Status : Commercialised